



 **Speedglas**<sup>™</sup>  
Welding Safety

**PROLINE**  
*Industrial*

**NEW**

Upgrade your performance

# 3M<sup>™</sup> Speedglas<sup>™</sup> Welding Helmet G5-03 Pro

3M Science. Applied to life.<sup>™</sup>

Ph: 0800 699 353  
[sales@prolinewelding.com](mailto:sales@prolinewelding.com)



# Farewell to compromises

The 3M™ Speedglas™ Welding Helmet G5-03 Pro Series is built for professional welders.

You need a welding helmet versatile enough that you don't have to compromise on function, performance OR safety.

The range includes both respiratory and non-respiratory welding helmets.



## Featuring NEW Speedglas™ Technology...



Powered Air with adjustable air distribution



3M™ Speedglas™ True-View and Variable Colour



Configurable extra protection and coverage options



New TAP technology to grind or cut



Advanced head harness for improved comfort and balance



Control your lighting with an optional task light

Respiratory



Speedglas G5-03 Pro Air

See page 4

Non-Respiratory



Speedglas G5-03 Pro

See page 8

# 3M™ Speedglas™ Welding Helmet G5-03 Pro Air

Designed for the professional welder, the 3M™ Speedglas™ Welding Helmet G5-03 Pro Air connects to the 3M™ Adflo™ Powered Air Purifying Respirator (PAPR) for industry leading respiratory protection.

**Extra-large viewing area with Side Windows**



**TAP function for grind & cut**

Read more on page 12

**New advanced optics**

Read more on page 10



**Large coverage area**



**Selection of extended coverage available**

Read more on page 15

**External adjustment of air distribution**

Read more on page 5



**Task light option**

Read more on page 14

## 3M™ Speedglas™ Welding Helmet G5-03 Pro Air

# Adjustable Air Distribution

Take complete control over the direction and movement of airflow within your welding helmet.

Direct the air flow over your face, head, or a combination of both. Customised air distribution helps prevent your eyes from drying out, leading to increased comfort.

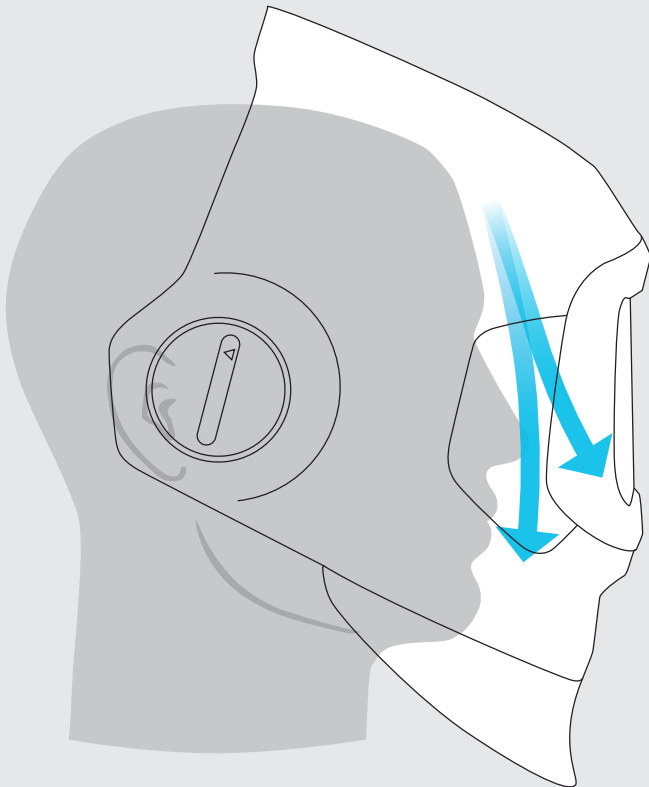

### Right side control

Direct the airflow to either your face, your visor, or a combination of both.

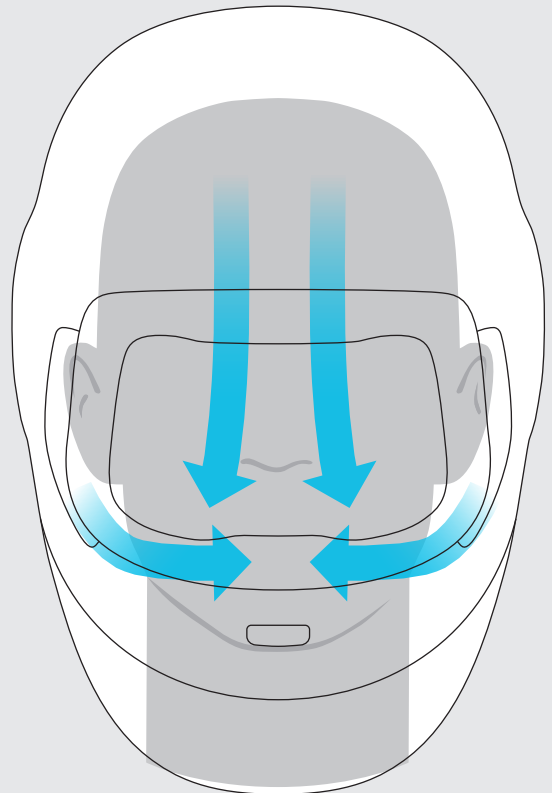

### Left side control

Adjust the amount of air coming from the top outlet vs. the two side outlets, or choose a combination of both.

# Heavy Duty Respiratory Protection

With a Required Minimum Protection Factor (RMPF) of 50, the Adflo PAPR provides at least 50 times cleaner air than the welder would be breathing unprotected.



# Mobile and Adaptable Respiratory Protection

## 3M™ Adflo™ Powered Air Purifying Respirator (PAPR)

As one of the most popular respirators of its kind in the world, the Adflo™ Powered Air Purifying Respirator is designed to provide a constant nominal airflow rate of 170/200 litres per minute, regardless of the battery's charge or the particle loading of the filter.

With its slim profile, the Adflo respirator offers excellent lightweight, adaptable and easy-to-use respiratory protection.

**See page 11 or 17 for ordering information.**

A heavy duty backpack designed for welding applications is now available to provide improved comfort and balance.



Heavy Duty PAPR Backpack  
Part No 954015HD

### Industry leading protection

Since its launch, the 3M™ Adflo™ powered air respirator has become synonymous with welders' respiratory protection. The system is designed to meet the specific needs of welders.

### Lightweight with Rapid Charge

The Adflo respirator is now over 15% lighter than the older style version with Ni-MH (black) battery. The lightweight battery charges up to 80% capacity in approximately an hour.

### Filtered air to breathe

Constant, clean air flows directly into your breathing zone. Choose between 170 litres per minute or 200 litres per minute (for hot, humid jobs) with the push of a button.

### Adaptable filtration

With the right type of filter, the Adflo powered air respirator effectively protects against a range of gases, vapours and particles.

### You only have one set of lungs

The Adflo respirator complies with Australian and New Zealand Standard AS/NZS 1716 for powered air respirators and offers a Required Minimum Protection Factor (RMPF) of 50 for mechanically and thermally generated particles.

### Heavy Duty Battery

An Adflo PAPR keeps you protected during long shifts. The Speedglas G5-03 Pro Air comes standard with the heavy duty Adflo battery, which can offer up to 12 hours continuous protection.

# Effective Respiratory Protection for the Welder

Without effective protection, welders are exposed to a known carcinogen - welding fume.

However, by law, it is the employer's responsibility to reduce welding fume exposure to as low as reasonably practicable.

The results of a recent scientific study\* have shown that a welding helmet with an integrated powered air purifying respirator can provide the welder with extremely effective respiratory protection.

Based on the results of the study, a Welding Helmet with integrated PAPR was the most effective method in protecting the welder from welding fume.

\* Read more on the study here

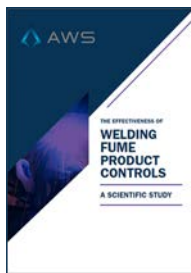

Technical Data	Heavy-Duty 3M™ Adflo™ Powered Air Respirator
Approvals Respiratory Protection	Conforms to AS/NZS 1716
Required Minimum Protection Factor (RMPF) <sup>1)</sup>	50
Airflow Standard Airflow Plus	170 litres/minute 200 litres/minute
Battery Operating Hours	12 hours
Charging time	Li-ion with rapid charge (0-80% in an hour) <sup>2)</sup> 4-5 hours full charge.
Gas and odour filters are available as an optional extra. 1) For mechanically and thermally generated particles. 2) Heavy duty battery will be 80% charged (9.6 hours run time) in approximately one hour.	



# 3M™ Speedglas™ Welding Helmet G5-03 Pro

The 3M™ Speedglas™ Welding Helmet G5-03 Pro is a non-respiratory helmet designed for professional welders.



**TAP function for grind & cut**  
Read more on page 12

**Extra-large viewing area with Side Windows**



**Ergonomic head harness**

**New advanced optics**  
Read more on page 10



**Large coverage area**

**Task light option**  
Read more on page 14

**Selection of extended coverage available**

Read more on page 15



Each 3M™ Speedglas™ auto-darkening lens comes with a revolving 3 year warranty. This means that if you experience any issues with your welding lens within that time, your period of cover effectively resets.

What's more, you can extend this warranty period by 12 months for free by registering your product at [www.apexweldingsafety.com.au](http://www.apexweldingsafety.com.au)



Ph: 0800 699 353  
[sales@prolinewelding.com](mailto:sales@prolinewelding.com)



# A more natural light state with Speedglas TrueView

With new 3M™ Speedglas™ TrueView Technology, colours appear even brighter and more realistic in both the light and dark states. A more realistic view can enable improved:

## Accuracy

Improved recognition of colours and contrast allows better control of your weld puddle.

## Productivity

Better focus on the welding setup, welding technique and inspection of just-completed welds.

## Quality

An increase in the quality and precision of the welds.

Dark state 8 with setting A - natural tones



Dark state 8 with setting B - cool tones

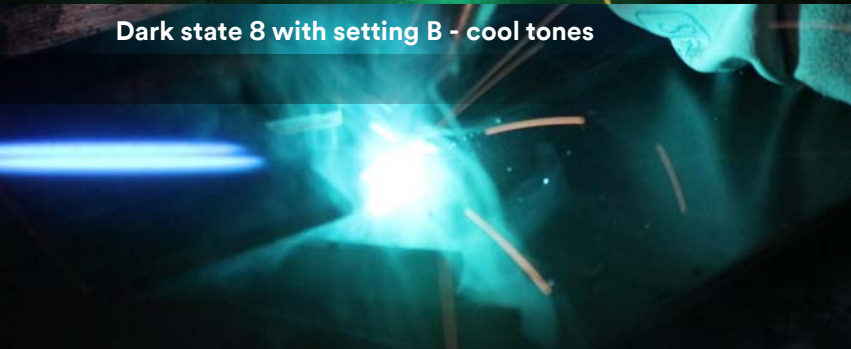

Dark state 8 with setting C - warm tones



## See your way...

To provide better vision and more control of your weld puddle, 3M™ Speedglas™ Variable Colour Technology allows you to choose between natural (A), cool (B), or warm (C) colour tones for your dark state.

You determine which colour tone provides the best viewing contrast for your welds, and the most comfort for your eyes.

# Choose the welding lens best suited to your work and personal preference

The 3M™ Speedglas™ Welding Helmet G5-03 Pro Air and 3M™ Speedglas™ Welding Helmet G5-03 Pro are available to order as complete systems with either welding lens below.



### G5-03 VC

Variable Colour Technology and Speedglas TrueView

---

Shades 3/5, 8-14 (14 for high amps)

---

New TAP function

---

Huge 73 × 109 mm viewing area with SideWindows

---

Four arc sensors detect down to 1 Amp



### G5-03 TW

Speedglas TrueView with Extra Light State

---

Shades 2.5/5, 8-13 (2.5 Extra Light State)

---

New TAP function

---

Huge 73 × 109 mm viewing area with SideWindows

---

Four arc sensors detect down to 1 Amp



### G5-03 NC

Speedglas TrueView

---

Shades 3/5, 8-12

---



Large 55 × 107 mm viewing area with SideWindows

---

Three arc sensors detect an arc down to 1 Amp

---

Does not feature TAP function

3M™ Speedglas™ G5-03 Pro System			
3M Speedglas G5-03 Pro Air with Adflo Powered Air	G5-03VC 63 77 30	G5-03TW 63 77 20	G5-03NC 63 77 10
3M Speedglas G5-03 Pro	63 18 30	63 18 20	63 18 10

**TAP** on the side of the welding helmet, with or without a glove, to easily switch between grind (or cut) mode and weld mode.

No need to remove your helmet and compromise your protection.

# Easy switching is just a TAP away

Switch quickly between modes (GRIND/CUT and WELD) by simply tapping the side of the helmet with your hand – even when wearing gloves.

The TAP function is robust and intuitive, and can be deactivated if needed.

Built into the G5-03TW and G5-03VC welding lenses\*, the TAP function can help to improve productivity with button-less control.



\* Please note that TAP Technology is not available with the G5-03NC welding lens.

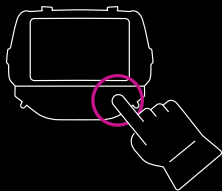

**1**

Use the interface on the lens to set if you want to use TAP function with grind or cut mode.



**2**

TAP on the side of the welding helmet to switch between GRIND and WELD mode or CUT and WELD mode.

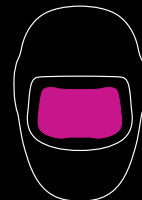

**3**

The welding lens will switch to the desired setting.



**4**

Tap again and the lens switches back to welding mode.

# Enhance your grinding

The 2.5\* light state in combination with an optional task light will allow you to grind with increased visibility. The TAP function allows for quick and easy switching between welding and GRIND mode.



**Light state 2.5**



**TAP function**



**Task light**

\*2.5 state is only on the G5-03TW Auto-Darkening Lens (ADL)



Designed to provide powerful uniform lighting from a welding working distance.

Positioned to cast a wide light on the workpiece with configurable light intensity.



## Let there be light...

Built specifically for welding, the optional helmet-mounted task light helps welders stay productive in poorly lit areas. It delivers a better view of the work area before and after welding, which can help to reduce fatigue.

3M™ Speedglas™ Task Light is designed to be low profile and lightweight.

For welders using the 3M™ Speedglas™ Welding Helmet G5-03 Pro Air, the task light is powered by the 3M™ Adflo™ Powered Air Purifying Respirator.

For welders using the Welding Helmet G5-03 Pro, a battery pack is available which connects to the rear of the welding helmet for a balanced fit.

**Powered by the Adflo**

**Or**

**Rechargeable battery**



**Ph: 0800 699 353**  
**sales@prolinewelding.com**

# Extend Your Protection

Do you require additional protection from heat, radiation, spatter and sparks?

There is a range of extended coverage options available to give you a more comfortable and protective environment.

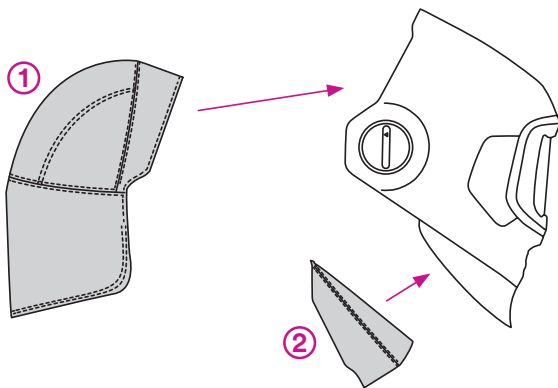

## ① Head Cover

Increase coverage of your head by adding a fabric head cover.

## ② Neck Protection

The lower section of the welding helmet can be removed and replaced with customised neck protection suited to the welder's working position and application.

## Spark Protection

Flame-retardant fabrics protect the welder from sparks and spatter.



> **Learn more about our range of extended head and neck protection on page 17.**

To maximize coverage from sparks, add the fabric shroud and the extended, larger fabric head protection



## Technical Specifications

3M™ Speedglas™ Auto-Darkening Welding Lens Series G5-03	 G5-03VC	 G5-03TW	 G5-03NC
MMAW (Electrode)	✓	✓	✓
MIG/MAG	✓	✓	✓
TIG (>20A)	✓	✓	✓
TIG (1A-20A)	✓	✓	✓
Plasma (welding and cutting)	✓	✓	✓
Hidden arc	✓	✓	✓
Tack welding	✓	✓	✓
Grinding	✓	✓	✓
Viewing area (welding filter)	109 × 73 mm	109 × 73 mm	107 × 55 mm
3M™ Speedglas™ TrueView Technology	✓	✓	✓
3M™ Speedglas™ Variable Colour Technology	✓	✗	✗
TAP function	✓	✓	✗
Bluetooth enabled	✓	✓	✗
Battery lifetime	1500–2000 hours	1500–2000 hours	2500 hours
Classification (ISO)	V2	V2	V2
Dark state	Shade 8–14	Shade 8–13	Shade 8–12
CUT mode	Yes shade 5	Yes shade 5	Yes shade 5
Tack welding mode	✗	✓	✗
Light state	Shade 3	Shade 2.5	Shade 3
UV/IR Protection	Shade 14 (permanent)	Shade 13 (permanent)	Shade 12 (permanent)
Auto ON	✓	✓	✗
Auto OFF	✓	✓	✓
Switching time, light-dark	0.1 ms (+23° C)	0.1 ms (+23° C)	0.1 ms (+23° C)
Memory mode	Yes, via mobile device app	Yes, via mobile device app	No
Delay (switching time, dark-light)	50 – 1300 ms	50 – 1300 ms	50 – 470 ms
Number of sensors (arc detection)	4	4	3

### Common parts between G5-01 and G5-03



For optimal flexibility onsite, many G5-01 spare parts are also compatible with G5-03. This allows you to hold less spare part inventory, while retaining the flexibility you need to customise your equipment.

All parts common with G5-01 are marked with a dot (•) after the part number.

Example: 16 90 30 • Shroud





**3M™ Speedglas™  
Welding Helmet G5-03 Pro**

G5-03 Pro with G5-03VC lens  
**Part No 63 18 30**

G5-03 Pro with G5-03TW lens  
**Part No 63 18 20**

G5-03 Pro with G5-03NC lens  
**Part No 63 18 10**

G5-03 Pro with no welding lens  
**Part No 63 18 00**



**3M™ Speedglas™  
Welding Helmet G5-03 Pro Air**

**Complete Systems**  
G5-03 Pro Air with G5-03VC lens, 3M™  
Adflo™ Powered Air Respirator and carry bag  
**Part No 63 77 30**

G5-03 Pro Air with G5-03TW lens, 3M™  
Adflo™ Powered Air Respirator and carry bag  
**Part No 63 77 20**

G5-03 Pro Air with G5-03NC lens, 3M™  
Adflo™ Powered Air Respirator and carry bag  
**Part No 63 77 10**

**Upgrade Kits**  
G5-03VC Pro Air Upgrade Kit  
(helmet, lens, and carry bag)  
**Part No 63 11 30**

G5-03TW Pro Air Upgrade Kit  
(helmet, lens, and carry bag)  
**Part No 63 11 20**

**Accessories**  
Common for G5-03 Pro and G5-03 Pro Air



16 90 22 ●



16 90 43 ●



16 90 20 ●



16 90 41 ●



16 90 42 ●



16 90 23 ●



16 90 30 ●



16 91 00 ●

16 90 35 ●

(●) A purple dot marks common parts with G5-01

Part Number	Description	Part Number	Description
16 90 20 ●	Head Protection Fabric (Small)	16 90 41 ●	Neck Protection Fabric (Small)
16 90 22 ●	Head Protection Leather	16 90 42 ●	Neck Protection Fabric (Large)
16 90 23 ●	Head Protection Fabric (Large)	16 90 43 ●	Neck Protection Leather
16 90 30 ●	Shroud	16 91 00 ●	Head Cape Tecaweld
16 90 35 ●	Extended Cover Kit (Shroud and Large Fabric Head Cover)		

### Accessories G5-03 Pro only



### Accessories G5-03 Pro Air only

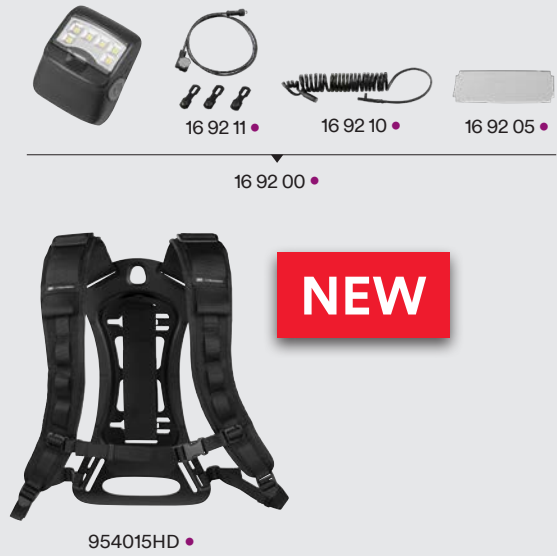

### Spare parts and consumables for Adflo PAPR



(•) A purple dot marks common parts with G5-01

Part Number	Description	Part Number	Description
16 92 00 •	Task Light, Inc Mounting Parts & Cables	83 70 20 •	Filter Particle PSL Adflo Pk=20
16 92 05 •	Lens Cover Task Light Pk=5	83 40 18 •	Tube Breathing Cover Flame Resistant Adflo
16 92 10 •	Long Power Cable for Task Light	83 71 10 •	Filter Odour Adflo
16 92 11 •	Short Power Cable for Task Light	83 71 20 •	Filter Odour Replacement Pad Adflo
16 92 15	Task Light Kit, Inc Battery & Cables	83 72 42 •	Filter Nuis Level Organic Vapour/Acid Gas Adflo
16 92 16	Task Light Battery Holder Inc Attachment Parts	83 75 42 •	Filter Gas A1 Adflo
83 60 10 •	Pre-Filter Adflo Pk=5	954015HD •	Backpack Adflo Heavy Duty
83 60 80 •	Pre-Filter Adflo Pk=80	ACK081	Rechargeable Battery
83 70 10 •	Filter Particle PSL Adflo	AL2AI/SP	Battery Charging Cable for ACK081

## Spare parts and consumables Common for G5-03 Pro and G5-03 Pro Air



## Spare parts and consumables G5-03 Pro Air only

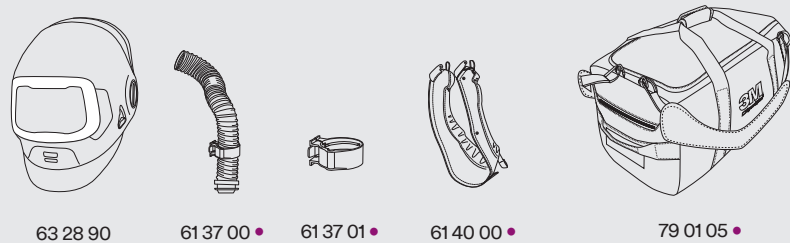

## Spare parts and consumables G5-03 Pro only



(•) A purple dot marks common parts with G5-01

Part Number	Description	Part Number	Description
16 95 02 •	Sweatband Pk=2	60 10 00 •	Battery Holder G5-03VC/TW
16 95 05 •	Sweatband Pk=5	60 20 00 •	Battery CR2450 G5-03VC/TW
17 10 20 •	Magnifying Lens 1.0X	61 00 21 •	Speedglas Welding Lens G5-03TW
17 10 21 •	Magnifying Lens 1.5X	61 00 31 •	Speedglas Welding Lens G5-03VC
17 10 22 •	Magnifying Lens 2.0X	61 05 01 •	Front Cover
17 10 23 •	Magnifying Lens 2.5X	61 32 00 •	Head Harness
17 10 24 •	Magnifying Lens 3.0X	61 37 00 •	Air duct Breathing Tube (Short) Inc Holder
17 10 35 •	Magnifying Lens Holder	61 37 01 •	Breathing Tube Holder
42 20 00 •	Battery Lithium G5-03NC Pk=2	61 40 00 •	Face Seal
52 60 00 •	Lens Cover Outer Standard Pk=10	61 60 00 •	Pivot & Sliding Mechanism Inc Pivot Knobs
52 70 00 •	Lens Cover Outer Hard Coated Pk=10	61 60 03 •	Head Harness Back Part
52 70 70 •	Lens Cover Outer High Heat Pk=10	63 00 10 •	Speedglas Welding Lens G5-03NC
52 80 15 •	Lens Cover Inner G5-03NC Pk=5	63 18 95 •	Helmet Shell G5-03 Pro exc. Head Harness
52 80 25 •	Lens Cover Inner G5-03VC/TW Pk=5	63 20 15 •	SideWindow Cover Plates Pk=2
52 80 28 •	Lens Cover Inner G5-03VC/TW Anti-Fog Pk=5	63 28 90 •	Helmet Shell G5-03 Pro Air exc. Head Harness
52 80 29 •	Lens Cover Inner G5-03NC Anti-Fog Pk=5	73 10 00 •	Battery Holder G5-03NC
53 62 10 •	Head Harness Back Cushion (Small)	79 01 05 •	Carry Bag Speedglas Heavy Duty
53 62 11 •	Head Harness Back Cushion (Large)		

3M™ Speedglas™ Generation 5 Welding Helmets

# The right equipment for each job



3M™ Speedglas™ Welding Helmet G5-01

Heavy duty welding and grinding



3M™ Speedglas™ Welding Helmet G5-02

Tig welding



3M™ Speedglas™ Welding Helmet G5-03

Welding and grinding



## 3M™ Connected Equipment App\*

- Program memory modes for dark shades, sensitivity, delay and more.
- New TAP settings.
- Get reminders for maintenance.
- Theft marking (engrave owner info) and serial number.
- Export or log ADL activity like hours on, hours in dark state, or number of on/off cycles.

\* Not available with G5-03NC welding lens.

Ph: 0800 699 353  
sales@prolinewelding.com